

**"...music so
beautiful that
it has to
be heard."**

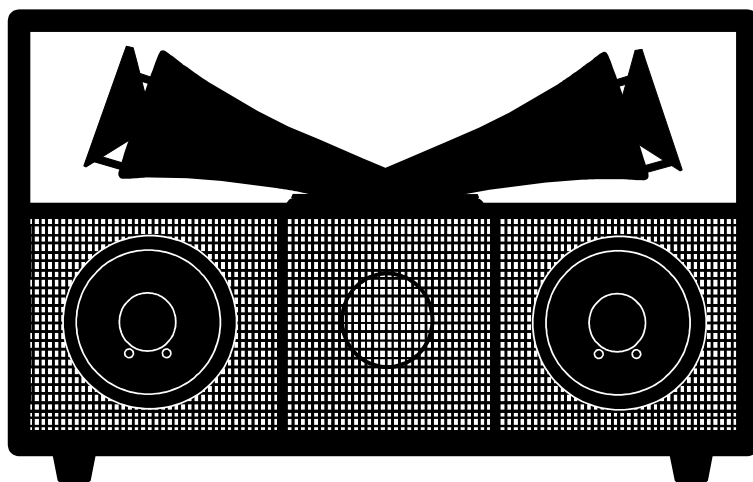

OWNER'S MANUAL

Leslie[®]

2101mk2

IMPORTANT SAFETY INSTRUCTIONS

Read these instructions.

Keep these instructions.

Heed all warnings.

Follow all instructions.

Do not use this apparatus near water.

Clean only with dry cloth.

Do not block any ventilation openings.

Install in accordance with the manufacturer's instructions.

Do not install near any heat sources such as radiators, heat registers, stoves or other apparatus (including amplifiers) that produce heat.

Do not defeat the safety purpose of the polarized or grounding-type plug. A polarized plug has two blades with one wider than the other. A grounding type plug has two blades and a third grounding prong. The wider blade or third prong is provided for your safety. If the provided plug does not fit into your outlet, consult an electrician for replacement of the obsolete outlet.

Protect the power cord from being walked on or pinched, particularly at plugs, convenience receptacles, and the point where they exit from the apparatus.

Only use attachments/accessories specified by the manufacturer.

PORTABLE CART WARNING



S3125A

Use only with the cart, stand, tripod, bracket, or table specified by the manufacturer, or sold with the apparatus. When cart is used: use caution when moving the cart/apparatus combination to avoid injury from tipover.

Unplug this apparatus during lightning storms, or when unused for long periods of time.

Refer all servicing to qualified service personnel. Servicing is required when the apparatus has been damaged in any way, such as power-supply cord or plug is damaged, liquid has been spilled or objects have fallen into the apparatus, the apparatus has been exposed to rain or moisture, does not operate normally, or has been dropped.

Apparatus shall not be exposed to dripping or splashing and no objects filled with liquids, such as vases, shall be placed on the apparatus.



注意：感電の恐れありキャビネットをあけるな

ATTENTION: RISQUE DE CHOC ELECTRIQUE NE PAS OUVRIR

WARNING: TO REDUCE THE RISK OF FIRE OR ELECTRIC SHOCK, DO NOT EXPOSE THIS APPLIANCE TO RAIN OR MOISTURE.

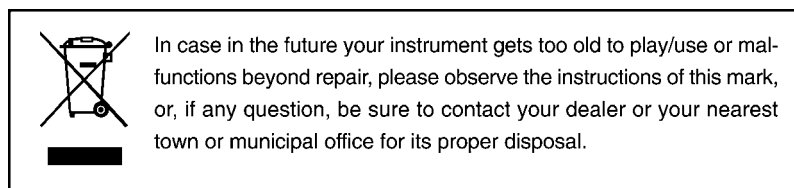
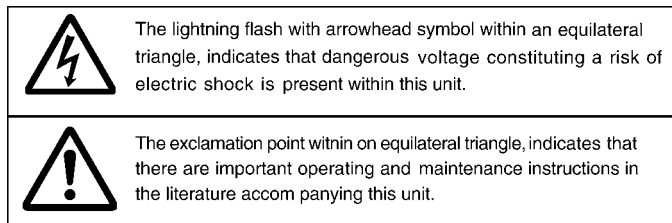

*The company name and the product name published in the manual are the trademarks or registered trademarks of each company respectively.

*The illustrations published in the manual are all the one for the operation explanation. Therefore, it might be different from an actual specification.



FOR UNITED KINGDOM:

FOR YOUR SAFETY, PLEASE READ THE FOLLOWING TEXT CAREFULLY

This appliance is supplied with a molded 3-pin mains plug for your safety and convenience.

The plug contains a 5 amp fuse.

Should the fuse need to be replaced, please ensure that the replacement fuse has a rating of 5 amps and that it is approved by ASTA or BSI to BS1362.

Check for the ASTA mark  or the BSI mark  on the body of the fuse.

If the plug contains a removable fuse cover, you must ensure that it is refitted when the fuse is replaced.

If the fuse cover is lost, the plug must not be used until a replacement cover is obtained.

A replacement fuse cover can be obtained from your local Hammond Dealer.

IF THE FITTED MOULDED PLUG IS UNSUITABLE FOR THE SOCKET OUTLET IN YOUR HOME, THEN THE FUSE SHOULD BE REMOVED AND THE PLUG CUT OFF AND DISPOSED OF SAFELY. THERE IS A DANGER OF SEVERE ELECTRICAL SHOCK IF THE CUT-OFF PLUG IS INSERTED INTO ANY 13 AMP SOCKET.

If a new plug is to be attached to the cord, please observe the wiring code as shown below.

If in any doubt, please consult a qualified electrician.

IMPORTANT - The wires in this mains lead are coloured in accordance with the following code:

Blue:	Neutral
Brown:	Live

As the colours of the wires in the mains lead of this unit may not correspond with the coloured marking identifying the terminals in your plug, proceed as follows.

The wire which is coloured BLUE must be connected to the terminal in the plug which is marked with the letter N or coloured BLACK.

The wire which is coloured BROWN must be connected to the terminal in the plug which is marked with the letter L or coloured RED.

Under no circumstances should either of these wires be connected to the earth terminal of the three-pin plug, marked with the letter E or the Earth Symbol .

To replace the fuse, open the fuse compartment with a screwdriver and replace the fuse and fuse cover.

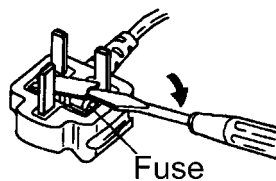

thank you...

for your purchase of the Leslie[®] Speaker System. Your new Leslie Speaker culminates many years of research and dedication to the art of sound reproduction. This new Leslie Speaker has been designed to provide the utmost in musical enchantment, plus dependable service.

The Leslie Speaker system sets revolutionary new standards of organ speaker performance, achieving heights of musical excellence never before considered possible. Not just another speaker - it marks a major breakthrough in organ sound, perhaps the most significant step forward since the introduction of the electronic organ.

Many features have been included in the speaker to insure the finest organ sound possible. Please take a moment to read this manual, then turn on your new Leslie Speaker and enjoy your organ playing to the fullest.

IMPORTANT - PLEASE READ

Your new Leslie Speaker is designed to give you the true and authentic Leslie Sound, as well as provide you great flexibility in how you want to play. This Guide is designed to explain the operating features of your Leslie Speaker as simply and graphically as possible.

This new Leslie has a number of Advanced Features which this Guide will explain in detail. Each feature is treated as an explanation unto itself, and does not require you to already have prior working knowledge of some other feature.

Do not be daunted by the number of steps required to perform each operation. Each step is simple. Simply bear these things in mind:

1. Read each step carefully.
2. Don't skip any of the steps.
3. Don't perform the steps out of sequence.

With these guidelines, you are well on your way to mastering all of the many sounds and features of your Leslie Speaker.

- Table of Contents -

A Brief History of the Leslie Speaker	6
Why Leslie Speed Controls?	6
2101mk2 Specifications & Description.....	7
Control Panel Guide	8, 9
Connecting Your Leslie 2101.....	10
Connecting to a single-channel Hammond Organ using the 11-pin socket.....	10
Connecting to the XK-3c/XK-3/XE-1/CMS-100/XT-series/XH-series using the 11-pin socket.....	11
Connecting using the 8-pin socket (XK-1, XB-1, XM-2, XM-1)	12
Connecting using the ROTARY IN jack without the special 8-pin cable	12
Connecting the Leslie 2121 Stationary-Unit	13
Connecting two Stationary-Units for Stereo Separation	14
Connecting two Horn Units to two Stationary-Units	14
Function and Preset Settings	15
Function Descriptions.....	16
How to change a Preset Parameter	17
To return to the Factory Default settings	17
Setting of system parameters.....	18
Controlling the speaker from another instrument via MIDI.....	19
Controlling the Advanced Features of the Leslie via MIDI	19
Preset Parameters	21
System Parameters	21
Parameter Settings.....	22
MIDI Information.....	23
MIDI Implementation Chart.....	24

◆ A Brief History of the Leslie Speaker

The Leslie Speaker was first developed in the late 1930's by Donald J. Leslie as a way to improve the sound of then-current Hammond Organs. Mr. Leslie found that rotating a baffle in front of a stationary speaker added a very pleasing “tremolo-type” sound to organ music. This technique is a musical application of the “Doppler effect,” which is the apparent variation in pitch that a stationary listener hears from a moving sound source. The loudness of the sound also appears to vary, and it is this combination of frequency (vibrato) and amplitude (tremolo) modulation that give Leslie Speakers their characteristic sound.

In the majority of Leslie Speakers, there are actually two rotating baffles and two speakers. One speaker handles the high frequencies and is mounted in the upper part of the cabinet. The baffle and motor for this speaker are collectively called the **Horn** Rotor. The other larger speaker reproduces the bass or pedal frequencies and uses a larger baffle, and is therefore called the **Bass** or **Low** Rotor.

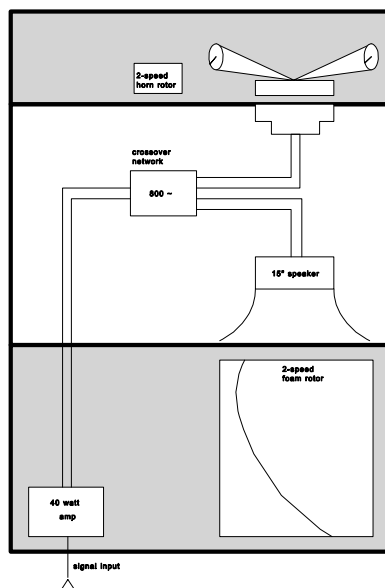

In addition to rotating a baffle at a high rate of speed to produce Tremolo, it is also possible to create a pleasing “Chorale “ or “celeste” effect by rotating the baffle at a slow rate of speed - hence the rotor speed designations of Fast and Slow. The Chorale effect is similar the effect produced by two ranks of pipes being slightly out of tune with each other and being played simultaneously on a pipe organ.

◆ Why Leslie Speed Controls?

For many years, Leslie Speakers only had one speed - Fast or Tremolo. Even after the Chorale speed was introduced in the mid '60's, variations in the basic speed were introduced by relocating the motor drive belt to a different pulley to make the baffles turn either faster or slower. Although each Leslie Speaker cabinet was and is carefully calibrated at the factory, several factors such as motor age and placement of the belts on the pulleys can affect the speeds of the rotors as well as the time required for the rotors to speed up (Rise Time), slow down (Fall Time) or come to a complete stop (Brake Time).

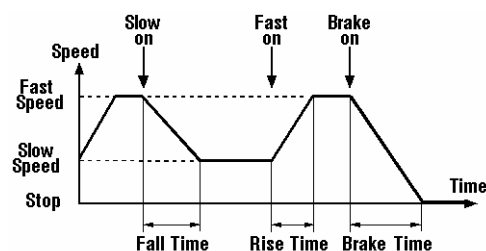

Your new Leslie Speaker features a new brushless DC-controlled motor for the Horn and a newly-designed digital Low rotor which allows control of these parameters to an unprecedented degree. You can now “customize” your Leslie Speaker to produce exactly the characteristics you want.

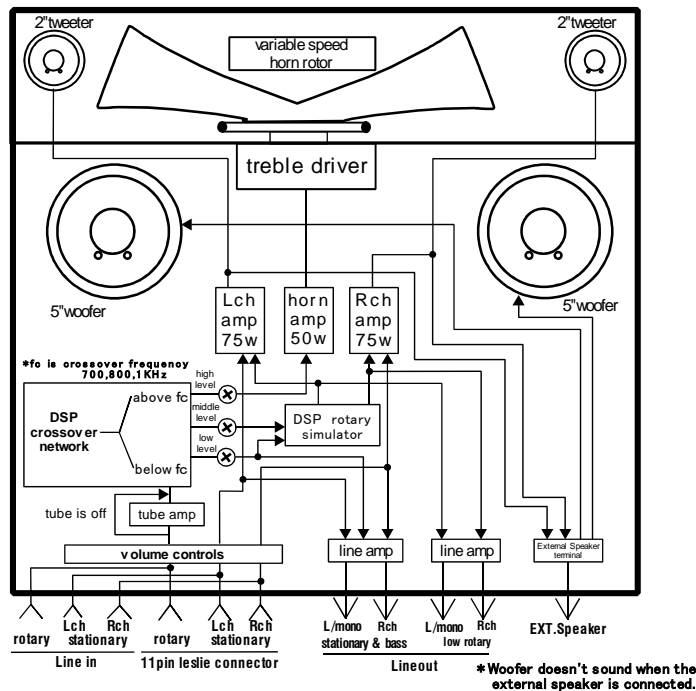

to insure
your
enjoyment
of
performing
music.

SPECIFICATIONS:

Type:

3-channel(ROTARY, STATIONARY-L,
STATIONARY-R)

Animation:

Horn Rotor, Digital Bass Rotor

Power Output:

Rotary Horn 50W. Stationary Channels
75W×2. 200 watts total.

Speakers:

Compression Driver for Horn,
13cm Woofer × 2, 5cm Tweeter × 2.

Controls:

Volume: STA-L, STA-R, ROTARY,
OVERDRIVE, TUBE MODE(SOFT-HARD),
8-position Function Selector
Touch Buttons: PRESET 1-2, MEMORY
Value: UP/DOWN

Stationary Channel Mode:

MONO/STEREO

Display:

7-segment, 2-digit LED display

Terminals:

Leslie 11-pin Socket, Leslie 8-pin
Socket, ROTARY INPUT, LINE OUT
(STATIONARY-L, STATIONARY-R,
ROTARY-L, ROTARY-R), MIDI IN, MIDI
OUT, REMOTE (Remote Power for #2121)
External Speaker OUT.

Foot Switch:

Foot Switch 1(PRESET), Foot Switch 2
(SLOW/FAST/STOP)

Power Consumption:

AC 120V, 220-230V, 230-240V 190W.

Dimensions:

51(W)×52(D)×33(H) cm

Weight:

23 kg

Optional Accessories:

Stationary-Unit #2121, Leslie 11-pin Cable(LC11-7M),
Leslie 8-pin Cable (LC8-7M), Stand Adapter(LSA-21),
Foot Switch (FS-9H), Speaker Stand(TS-70B).
External Speaker System(LPS-21)

The Leslie® model 2101mk2 contain two rotors to produce the world-renowned Leslie Speaker "Sound-In-Motion®." The sound is "separated" with the highs reproduced by a horn rotor and the lows reproduced by a two 5" speakers with electronic rotor capability. Both the mechanical and electronic rotors can be operated in two modes - Fast (Tremolo) or Slow (Chorale).

In addition, there is a stationary channel designed to accommodate the audio signal from another sound source such as a synthesizer or external sound module. This audio signal is handled by three speakers -the two 13cm speakers which also handle the lower frequencies for the rotary channel, and two 5cm dome tweeters for the high frequencies.

Control Panel Guide

- ① **11-pin Socket**
Allows direct connection between the a Leslie Speakers and the Hammond Organs
The LC11-7M 11-pin cable is optional and may be purchased from your authorized Hammond/Leslie Dealer.
- ② **8-pin DIN Socket**
Allows direct connection between a Leslie Speaker and Hammond Models XK-1,XB-1,XM-2 and XM-1 Using the special 8-pin cable provided.
- ③ **LINE IN JACK**
ROTARY: Input for the Rotary speakers for Organs/Instruments without the multi-pin Leslie connector.

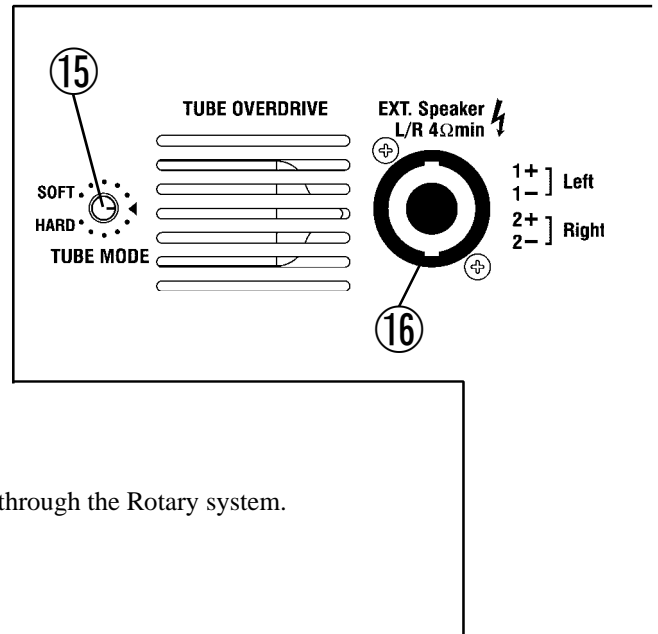

STATIONARY L,R: Input for the stereo stationary speakers.
Signals received here will not be passed through the Rotary system.

- ④ **STATIONARY Input Select**
STEREO : L and R input are output in stereo.
MONO : L and R input are summed into mono.

- ⑤ **LINE OUT JACK**
Each **LINE OUT JACK** is Stereo Jack.
The maximum effect is achieved by using "Y" cable of the stereo.
Please let me output only "L" signal by using the mono-cable for the thing.
STATIONARY & BASS (L/MONO, R) : Allows both the **STATIONARY** and the **LOW ROTARY** channels to be connected to an external amplifier. To connect the **STATIONARY UNIT** (Optional) Companion Leslie Model #2121 Stationary Amplifier, connect the L/MONO OUT to INPUT 2 on the Leslie Model #2121.

ROTARY (L/MONO, R) : Allows the **LOW ROTARY** channel to be connected to an external amplifier.
To connect the **STATIONARY UNIT** (Optional) companion Leslie Model #2121 Stationary Amplifier, connect the L/MONO OUT to INPUT 3.

NOTE: The **HORN ROTOR** channel has no **LINE OUT** connection due to the acoustic nature of the sound produced.
Using the **HORN Rotary** channel with external amplification requires a microphone.

- ⑥ **AC Inlet**
Plug the female end of a grounded AC power cord into this receptacle, and the male end into an AC outlet.



CAUTION

This unit shall be connected to a **MAINS** socket outlet with a protective earth connection.

- ⑦ **REMOTE**
When the Leslie 2121 Stationary-Unit is connected, connect to the **REMOTE IN** with a DCC-2 cable. The power for the Stationary-Unit can be turned "ON" and "OFF" by the power switch of the Horn-Unit.

- ⑧ **Power Switch ON / OFF**
This allows the Leslie Speaker to be turned "ON" or "OFF".
When the 11PIN Leslie Cable is connected.
set the Power switch to the "Off" position. When the attached Hammond Organ is switched "on", the Leslie 21 system will also power on.



CAUTION

Even when the **POWER** switch is turned off, electricity is still flowing to the instrument at the minimum level.
When you are not using the instrument for a long time, make sure you unplug the power cord from the wall AC outlet.

- ⑨ **FOOT SW**
PRESET : Allows switch alternate between **PRESET 1** and **2** using a latching-type Foot Switch.

SLOW/FAST/STOP : Allows you to control the speed of the Leslie rotors using the optional FS-9H Foot Switch.
Each time the Foot Switch is activated, the rotors will switch between **SLOW** and **FAST**.
If the Foot Switch is pressed and held for more than 1 second, the Rotors will Stop.

Continued on next page.

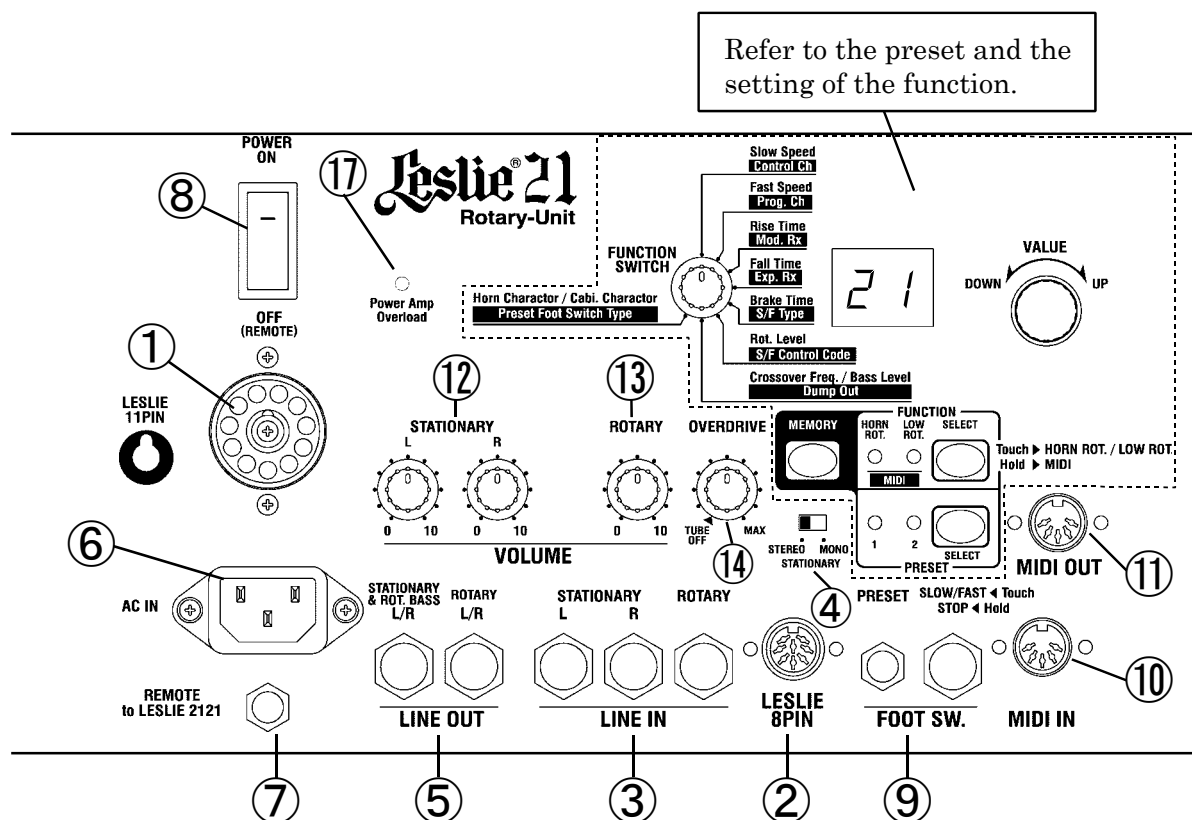

⑩ MIDI IN

Connects to the MIDI OUT of an organ or keyboard organ, keyboard, or external device.

⑪ MIDI OUT

Connects to the MIDI IN of an additional Leslie model 21 Horn-Unit when 2 units are connected in series. The MIDI IN from the organ and the FOOT SW signal of the Horn-Unit are merged in the MIDI OUT.

⑫ STATIONARY VOLUME CONTROLS

L : Allows the volume adjustment of the Stationary Left channel.

R : Allows the volume adjustment of the Stationary Right channel.

⑬ ROTARY

Adjusts the volume of the Rotary channel.

⑭ OVERDRIVE

Adjusts the Overdrive Level of the Rotary channel.

⑮ TUBE MODE

Controls the characteristics of the genuine Tube preamp.

At "soft" the overdrive is warm and smooth, as you progress to "hard" the overdrive becomes stronger and "crunchier".

⑯ EXT. Speaker

Neutrik NL4FX type Spicon output terminal.

For the optional Leslie External Speaker LPS-21.

The connectors are four-contact, with the legend shown at right.

The impedance of the speaker must be greater than 4 ohm.

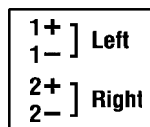

⑰ Power Amp Overload

Illuminates as the maximum output of the power amplifier is approached.

Connecting Your Leslie 2101

- ◆ Connecting to a single-channel Hammond Organ using the 11-pin socket
New B-3 , XK-2

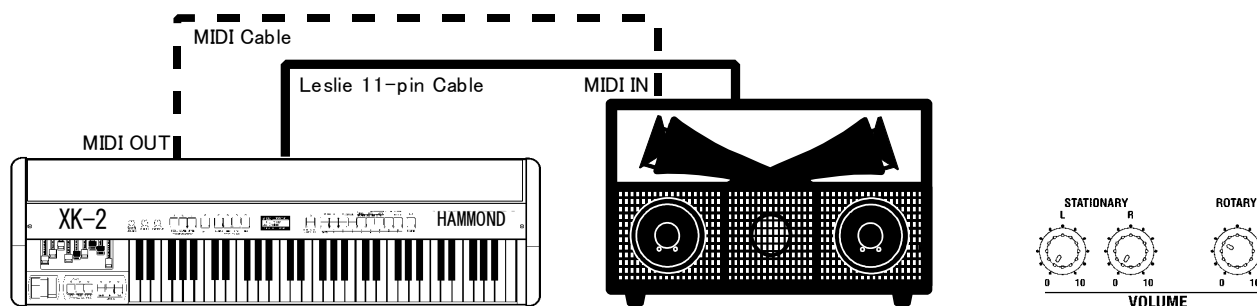

The above example shows a Hammond XK-2 connected to a Leslie model 2101 Horn Unit. The audio signal is connected connection is made via an the optional 11-pin Leslie Cable.

Properly connect:

1. Make sure the power of both units is “OFF.”
2. Set the STATIONARY Volume Controls on the Leslie Speaker to “0” or Off , since the XK-2 only uses the Rotary channel.
3. Set the ROTARY Volume Control to a low setting (the 10 o’clock position is recommended) when first making the connection.
4. Plug the female end of the Leslie Connector Cable into the 11-pin socket on the back of the Leslie model 21 Speaker.
5. Plug the male end of the Connector Cable into the 11-pin Leslie socket on of the organ.
6. Turn the organ “ON.” After about 5 seconds, the Leslie Speaker will turn “ON.” Then adjust the volume settings of both units to your liking need.

NOTE: In addition, a MIDI cable can be connected from the MIDI OUT of the XK-2 to the MIDI IN of the Leslie to allow the XK-2 to control the Advanced Features of the Leslie. Please see page 22 for more information.

NOTE: The above connection instructions will also work with older Hammond products such as XB-2, XB-5 and XB-3; however, all MIDI features may not be available. Please see page 21 for more information.

- ◆ Connecting to the XK-3c/XK-3/XE-1/CMS-100/XT-series/XH-series using the 11-pin socket

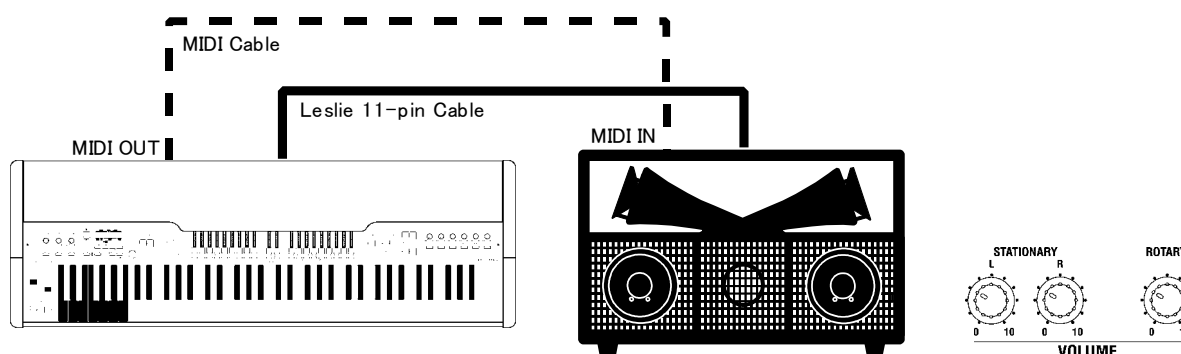

The above example shows a Hammond XK-3c connected to a Leslie model 2101 Horn Unit. The audio signal is connected via an optional 11-pin Leslie Cable. The above connection instructions can be used with any current Hammond Organ; however, all MIDI features may not be able to be controlled. Please see page 21 for more information.

To make this connection:

For XK-3c , XK-3

Locate the LESLIE mode on the XK-3c

1. Press the [MENU/EXIT] button to display the MENU.
Select PAGE C by the PAGE button and press [3] LESLIE
2. Or, hold down either [LESLIE BRAKE], [LESLIE ON], or [LESLIE FAST]
3. Press the [PAGE UP] button until the "EXT. LESLIE CH" appears in the display
4. Select "2 or 3" as the value in this display

▼EXT. LESLIE CH
2or3

1. Make sure the power to both units is "OFF."
2. Set the STATIONARY Volume Controls on the Leslie Speaker to a low setting (the 10 o'clock position is recommended) when first making the connection.
3. Set the ROTARY Volume Control to a low setting (the 10 o'clock position is recommended) when first making the connection.
4. Plug the female end of the Leslie Connector Cable into the socket on the back of the Leslie Speaker.
5. Plug the male end of the Connector Cable into the 11-pin Leslie socket of the organ.
6. Turn the organ "ON." After about 5 seconds, the Leslie Speaker will turn "ON." Then adjust the volume settings of both units to your liking.

NOTE: In addition, a MIDI cable can be connected from the MIDI OUT of the organ to the MIDI IN of the Leslie to allow the organ to control the Advanced Features of the Leslie.

◆ Connecting using the 8-pin socket (XK-1, XB-1, XM-2, XM-1)

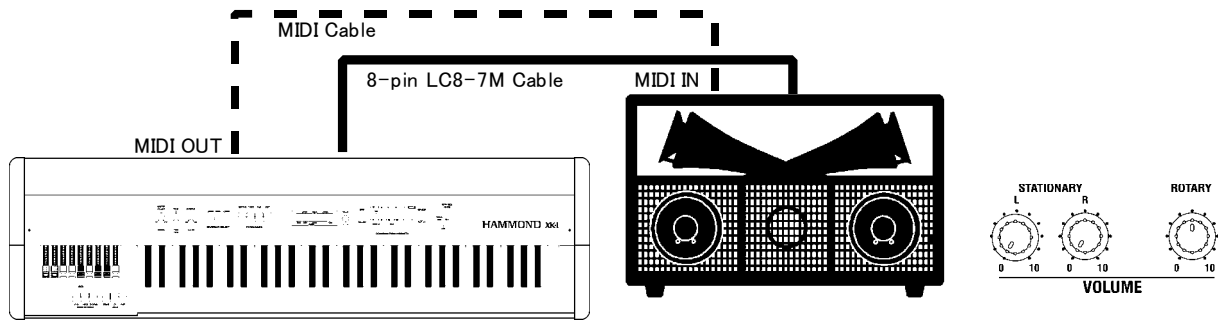

The above example shows a Hammond XK-1 connected to a Leslie Model 2101 Horn Unit. The audio signal is connected via the special 8-pin cable. In addition, a MIDI cable can be connected from the MIDI OUT of the XK-1 to the MIDI IN of the Leslie to allow the XK-1 to control the Advanced Features of the Leslie.

NOTE: The Remote Turn-on feature is not available when using the 8-pin interface.

◆ Connecting using the ROTARY IN jack without the special 8-pin cable

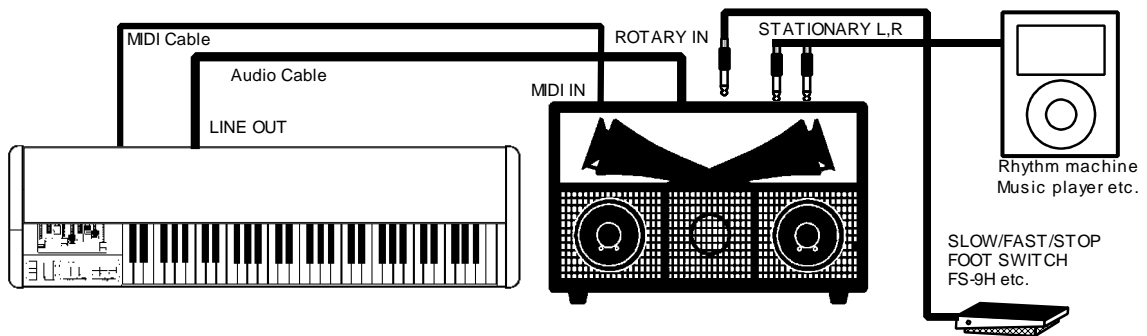

You may use the Leslie Model 2101 with other organs, keyboards and external devices that do not have the special 8-pin jack

The above example shows a connection using the LINE OUT of another instrument. The audio signal is connected via a 1/4" patch cord from the LINE OUT jack (or the L/MONO jack if there is more than one) to the ROTARY IN jack of the Leslie.

Set the rotary volume on the Leslie Model 2101 to is made about 10 o'clock.

Set the STATIONARY L and R volume so that the rhythm machine and the or music player, etc. may become proper are at the desired volume.

Turn off any Rotary speaker simulator installed on keyboard or organ when you use the Leslie Model 2101.

NOTE: You may also use the L/MONO jack of a Hammond instrument in this fashion; however, you will NOT be able to control the rotor speed using the Touch Tabs. Use a Foot Switch for this purpose.

◆ Connecting the Leslie 2121 Stationary-Unit

To connect the Leslie 2121 Stationary-Unit to the Leslie 2101 Horn-Unit, do the following:

1. Make sure the power to all units, including the connecting instrument, is “OFF.”
2. Connect the Stationary Unit as shown below. Set the controls on the Stationary-Unit similar to the settings shown below.
The rotary channel each part volumes are set to the following factory values .

HORN LEVEL : 90 / LOWER LEVEL : 99 / BASS LEVEL : 90

3. Please set the Volume levels of 2121 INPUT 2 and of INPUT 3 of the Leslie Model 2121 stationary unit referring to the figure below.

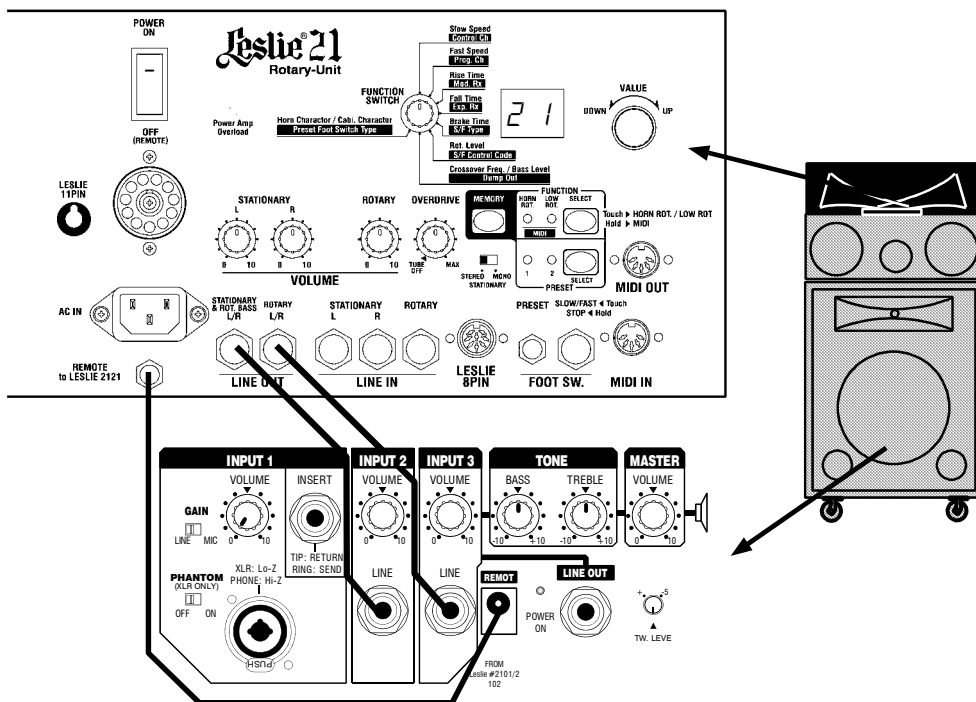

NOTE: the two LI-40 audio cables and the DCC-2 power connecting cable are supplied with the 2121 Stationary-Unit.

4. Turn on the LINE connected instrument. Both Leslie units will be powered up automatically.
5. Finally, turn the MASTER VOLUME Rotary Control of the 2121 to the center (12 o'clock) position to check the sound level, then adjust the sound to your taste need.

◆ Connecting two Stationary-Units for Stereo Separation

The digital LESLIE low rotor can be heard three-dimensionally by use of a stereo connection.
The remote Power-On function will not work in on the second Leslie Model 2121 Stationary Unit.

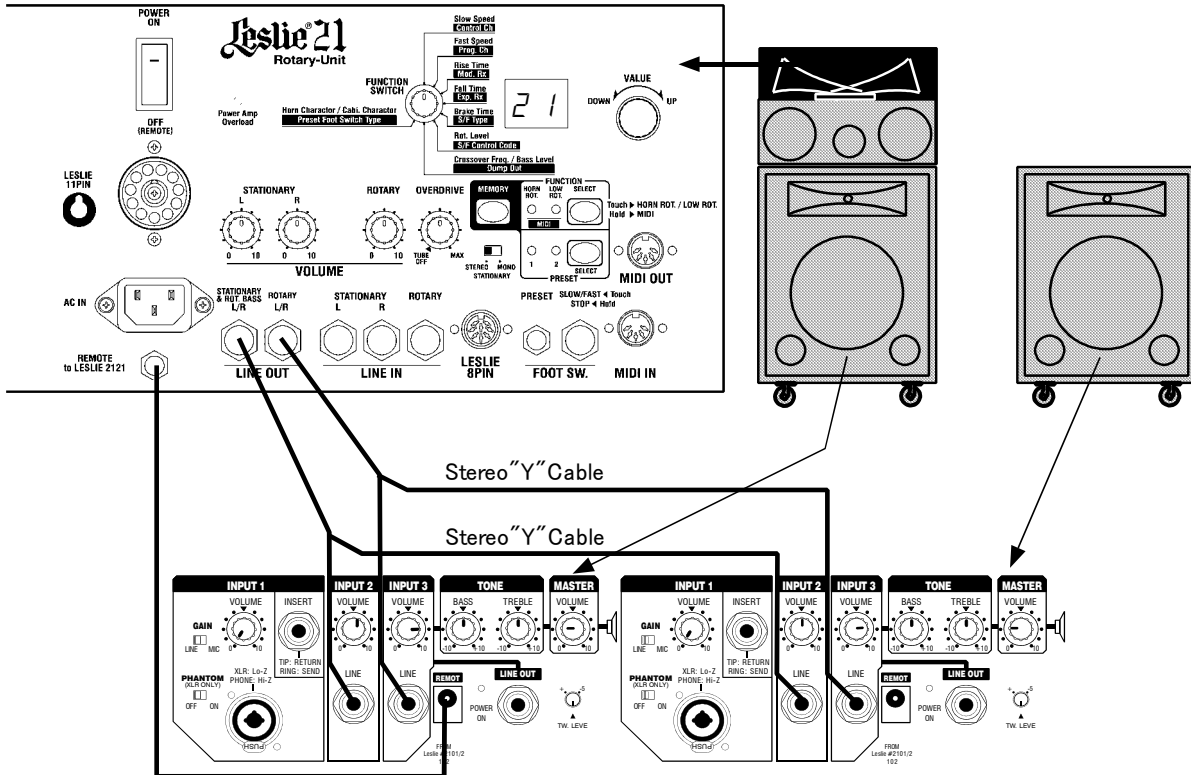

◆ Connecting two Horn-Units to two Stationary-Units

The ultimate performance of the Leslie 21 system.

Leslie 11-pin "Y" Cable

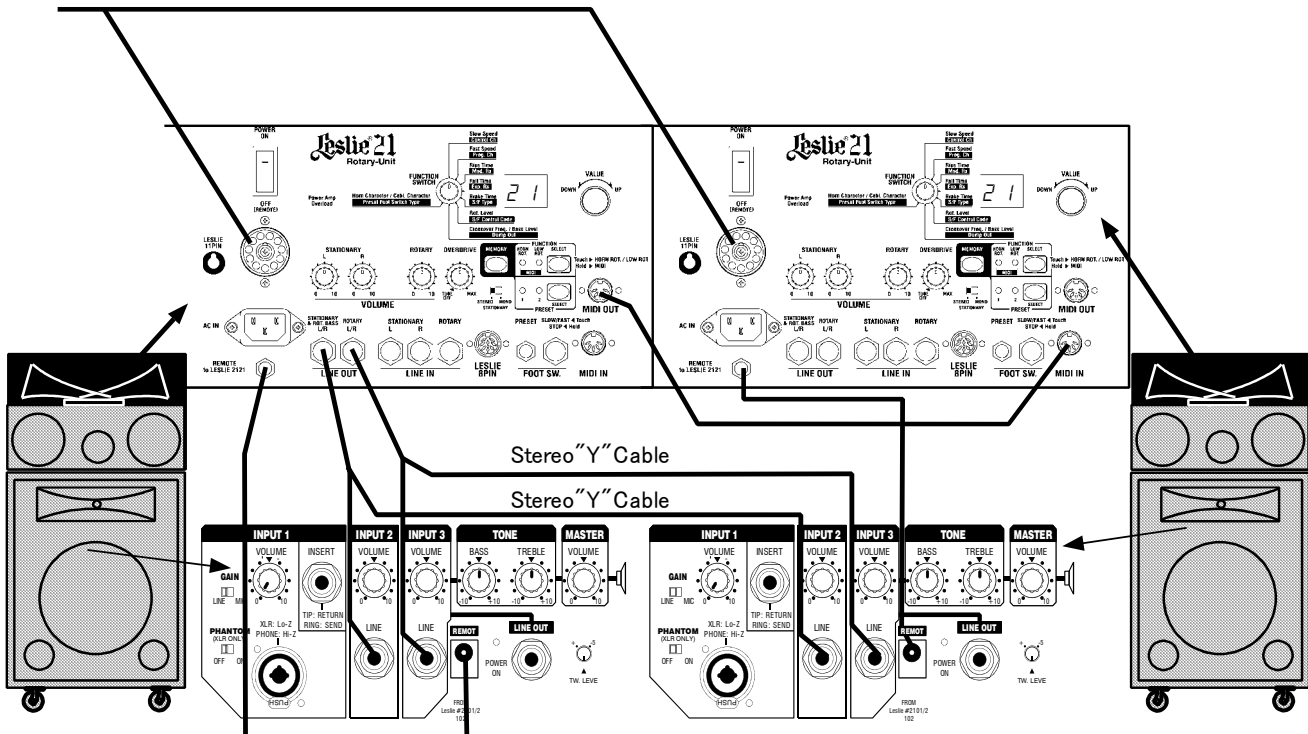

Function and Preset Settings

Editing of 16 different parameters for both rotors and saving those settings to memory using 2 presets.

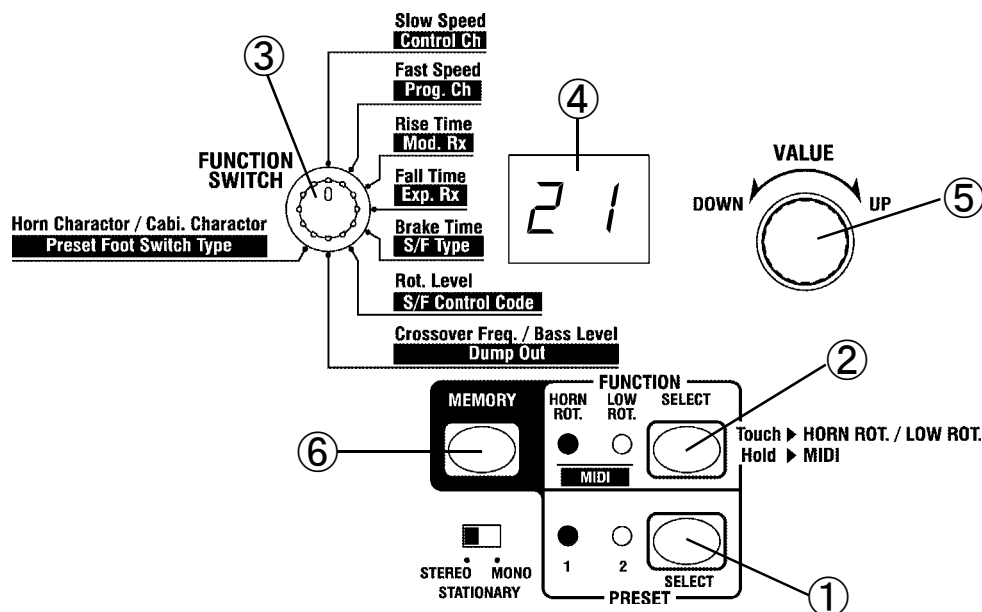

① PRESET SELECT

Whenever the button is pushed, PRESET 1 and PRESET 2 are alternately selected.
 You may select the PRESET with the optional the foot switch connected with to the PRESET Jack.
 Factory Default Set : PRESET1---- Imaged model 122.
 PRESET2---- Imaged model 21H.

② FUNCTION SELECT SWITCH

Pressing the button alternates the editing focus between the Horn rotor and the Digital Low Rotor.
 The indicator light will illuminate under the currently selected function.
 Holding the button for one second or more switches the editing focus to the MIDI functions.
 Both indicator lights will illuminate.

③ FUNCTION DIAL

An 8-position dial that selects the parameter to edit.

④ LED DISPLAY

Displays the value of the currently selected parameter.

⑤ VALUE UP/DOWN

An infinite rotary control to set the value of the currently selected parameter.

⑥ MEMORY

Pressing and holding the Memory switch for one second will save all the adjustable parameters in the preset currently selected.
 The corresponding LED will blink to confirm the save.
 The presets are held in memory even when the power switch is off and the mains are disconnected.

Function Descriptions

HORN ROTOR

1. Slow Speed : The horn rotor's slow speed is set.
2. Fast Speed : The horn rotor's fast speed is set.
3. Rise Time : The transition time from slow to fast is set in seconds.
4. Fall Time : The transition time from fast to slow is set in seconds.
5. Brake Time : The transition time from fast to full stop is set in seconds.
6. Rot.Level : The volume of the horn rotor is set.
7. Cross Over Freq : The crossover point from drum rotor to horn rotor is set.
There are three choices($f_c=0.7, 0.8, 1.0\text{kHz}$)
8. Horn Character : The frequency response of the horn rotor is set.
Flat.... The sound of usual characteristic.
1.0k.... 1.0kHz are emphasized.
1.6k.... 1.6kHz are emphasized.
2.0k.... 2.0kHz are emphasized.

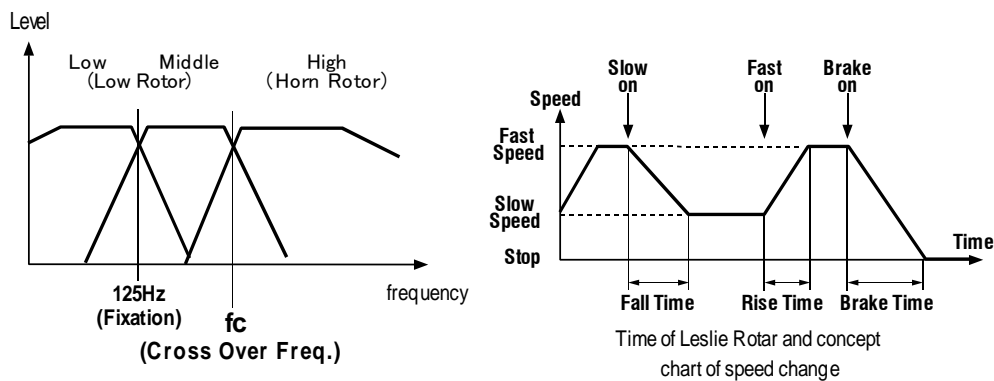

LOW ROTOR

1. Slow Speed : The Digital Low rotor's slow speed is set.
2. Fast Speed : The Digital Low rotor's fast speed is set
3. Rise Time : The transition time from slow to fast is set in seconds.
4. Fall Time : The transition time from fast to slow is set in seconds.
5. Brake Time : The transition time from fast to full stop is set in seconds.
6. Rot.Level : The volume of the low rotor middle frequencies is set.
7. Bass Level : The volume of the low rotor bass frequencies is set.
8. Cabi.Character : The characteristic of the virtual leslie cabinet cabinet is set.

The characteristics include: The frequency response, the tremolo, the depth of the chorus, and the simulation of reverberations.

The choice of types of cabinets are: 122 type.... The sound of the most familiar Leslie "Model 122"
21H type.... The 21H is a much-desired vintage Leslie,

with clear and distinct tone.

This setting is enhanced by using the vibrato/chorus on your organ

Bright type.... Punchy "bright" sound. This setting compliments an overdriven organ sound.

Flat type.... Plain sound near "Model 2101".

How to change a Preset Parameter.

In this example, you will change the Level of the horn rotor.

STEP ① Preset 1 or 2 or is selected pushing the PRESET SELECT button.

-----Select a preset to change, in this case select Preset #2
by pressing the [SELECT] button until the #2 LED lights

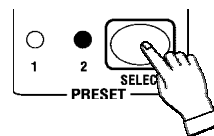

STEP ② HORN ROTOR or LOW ROTOR is selected pushing the FUNCTION SELECT button.

-----Press the [SELECT] button until the LED for "Horn rotor" is illuminated.

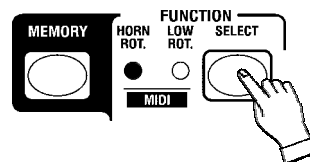

STEP ③ Use the FUNCTION DIAL to select which function to edit.

----- Turn the function select dial to [ROT. LEVEL].

STEP ④ The current value is shown in the LED display.

The Factory Default value is "50"

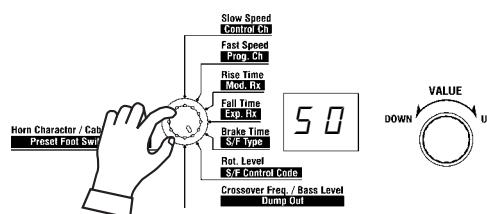

STEP ⑤ The VALUE UP/DOWN dial is turned and the numerical value is changed.

----- Using the [VALUE] dial, turn it fully to the right. The display will read "99"
and the horn volume is at maximum.

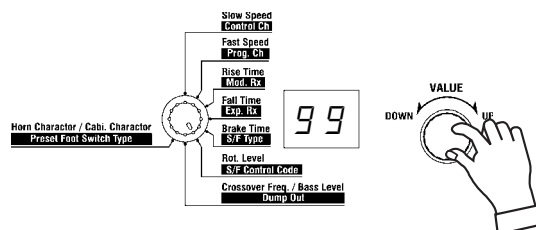

STEP ⑥ Enter the edit into memory by pushing the [MEMORY] button for one second.

repeat the operation from STEP2 to STEP5
to change other parameters values.

When you change two or more settings in the same preset.
committing the preset to memory records all the changes made.

Attention. Changes made will revert back to the previous settings if not saved to memory,
if the preset is switched, or the 2101 is powered off

To return to the Factory Default settings.

Press and Hold the red MEMORY Button.

Continue to hold the MEMORY Button , and turn the Leslie 2101 Power "ON"
"In" is displayed in LED during the processing time.

The factory default settings have now been restored.

Setting of system parameters.

Press and hold the [FUNCTION SELECT] button for one second or more until both indicators are illuminated.

Attention. The System parameters are "global" and are common to both presets.
The settings are stored as you change them, and remain in storage after power-down.

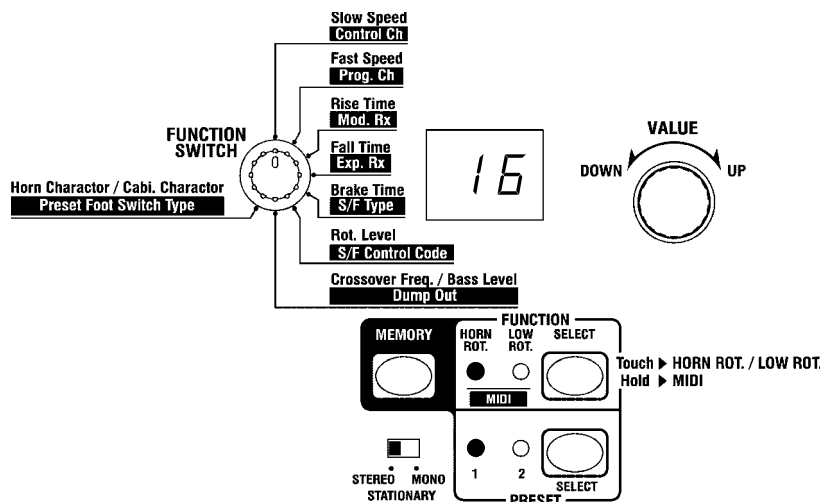

MIDI FUNCTION

- 1.[Control Ch] : Sets Control change reception ON/OFF and MIDI channel (1-16).
- 2.[Prog. Ch] : Sets Program change reception ON/OFF and MIDI channel (1-16)
Presets 1 and 2 are switched by programs 1 and 2.
- 3.[Mod Rx] : Sets the reception of speed control by the modulation wheel ON/OFF.
- 4.[Exp Rx] : Sets the reception of speed control by the Exp. Pedal.
- 5.[S/F Type] : 6.By the control change to which is set
Latch(LA)/Unlatch (uL) of the Slow/Fast switch is set.
Sets the type of foot switch for Latched (LA) or Unlatched (uL) control.
For use of the optional Leslie "FS-10L" set this parameter to (LA).
uL : For momentary control. When the footswitch is pressed,
"Fast" speed is selected and held until the footswitch is released.
LA : "Slow" and "Fast" are alternately selected with each press of the footswitch.
- 6.[S/F Cont.Code] : The control code of the Slow/Fast switch is set.
The factory default is CC#64. The range is CC#0-#99.
- 7.[Dump Out] : The system dump is via the MIDI OUT Jack.
Use this function to record preset and system parameters into a MIDI sequencer,
or to synchronize another 2101mk2.

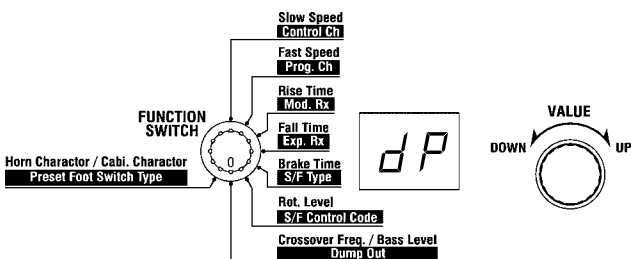

1. Select [DUMP OUT] with the [FUNCTION] dial.
2. Arm the MIDI sequencer for record, and begin recording.
3. Move the [VALUE] switch until the LED display "dp" begins to blink. When the blinking stops, the dump is complete.

Setting of foot switch

- 8.[P.F.SW Type] : Preset Foot Switch Type
Sets the type of foot switch for preset 1 and 2 switch is set control.
uL or LA (See above for description of "uL" and "LA")

Controlling the speaker from another instrument via MIDI

Your Leslie Speaker gives you the capability to control the Leslie parameters via MIDI. The Low Rotor is controlled through software via DSP, while the Horn Rotor uses a special brushless DC motor which responds to incoming MIDI Controller data.

Hammond Organ models which have Leslie parameter controls in the Information Center Display such as XK-3c, XK-3, XK-1, XB-1, XK-2, XE-1, CMS-100-series, A-305, and XT/XH-series home organs can control the rotors and sound characteristics of the Leslie Speaker in addition to the built-in digital Leslie simulator.

Non-Hammond keyboards such as synthesizers, MIDI master keyboards, etc., can also control the rotors and sound of this Leslie Speaker without going through the 11-pin Leslie interface.

NOTE: The MIDI NRPN must be "ON."

Please consult Your instrument's Owner's Playing Guide/Manual for the proper instructions .

◆Controlling the Advanced Features of the Leslie via MIDI

Example of control by XK-3c

(Consult the Owners guide of the XK-3c for directions on how to navigate to the following screens)

1. Select "21" as the value of LES on the MAST screen of the MIDI page.

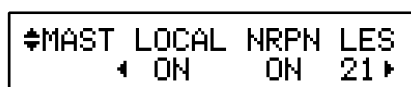

2. (On the Leslie 2101mk2)
Set FUNCTION switch to HORN ROTOR
Set FUNCTION DIAL to SLOW SPEED
(On the XK-3c)
Navigate to the HORN SPEED screen of the LESLIE PARAMETER page.
Move the cursor to SLOW SPED

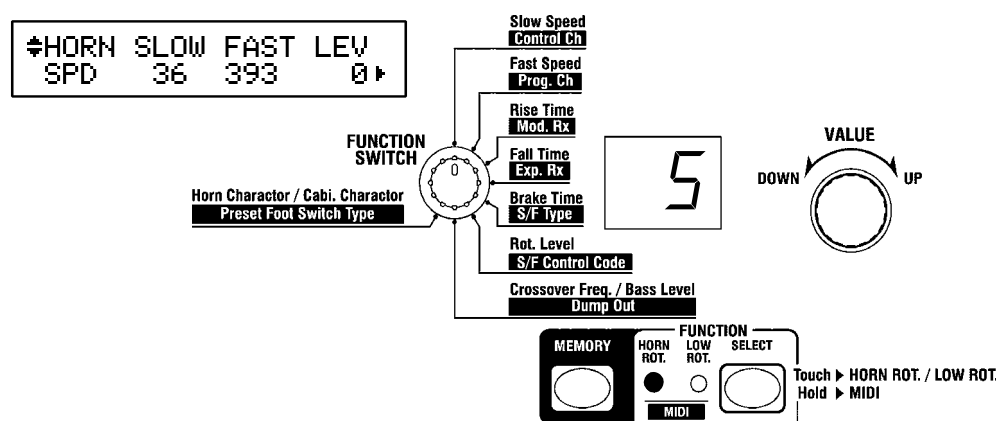

3. The LCD Display changes when HORN SLOW SPEED value of XK-3c is changed. The LED display of this unit the Leslie 2101mk2 synchronizes at the same time.

Attention. The XK-3c's parameter value must correspond with the available values offered by the 2101mk2. The 2101mk2 will not accept values outside the range.

Preset Parameters

Category	Parameter	NRPN Adr.		DATA Range		Default	
		LSB (62)	MSB (63)	MSB (06)	LSB (26)	Preset1	Preset2
Horn Rotor	Slow Speed	7F	00	0 - 99 (0,24-318rpm) *1	-	8(46rpm)	8(46rpm)
	Fast Speed	7F	02	1 - 27(375-450rpm) *2	-	9(400rpm)	9(400rpm)
	Rise Time	7F	04	0-39(0.2-12.5s) *5	-	4.2s	4.2s
	Fall Time	7F	06	0-39(0.2-12.5s) *5	-	3.4s	3.4s
	Brake Time	7F	08	0-39(0.2-12.5s) *5	-	3.6s	3.6s
	Horn Character(mk2)	7F	1C	0-3(FL,1.0k,1.6k,2.0k) *7	-	FL	FL
	Rot Level	7F	19	0-99	-	50	50
Low Rotor	Slow Speed	7F	01	0-9(0,24-48rpm) *3	-	8(46rpm)	8(46rpm)
	Fast Speed	7F	03	1-21(372-431rpm) *4	-	9(400rpm)	9(400rpm)
	Rise Time	7F	05	0-24(0.5-14.0s) *6	-	12s	12s
	Fall Time	7F	07	0-24(0.5-14.0s) *6	-	12s	12s
	Brake Time	7F	09	0-24(0.5-14.0s) *6	-	12s	14s
	Rot Level	7F	1A	0-99	-	99	99
	Bass Level	7F	1B	0-99	-	99	99
Horn&Low Rotor	CrossOver Frequency	7F	0E	0-2(0.7k,0.8k,1.0k)	-	0.8k	0.8k
	Cabinet Character(mk2)	7F	1D	0-3(12,21,br,FL) *8	-	12(122)	21(21H)

System Parameters

Category	Parameter	NRPN Adr.		DATA Range		Default
		LSB (62)	MSB (63)	MSB (06)	LSB (26)	
Preset	Preset Number	7F	10	0,1(Preset1,Presets2)	-	0(Preset1)
MIDI System	Control Channel	7F	11	0-16(1-16channel,Off)	-	0(1Channel)
	Program Channel	7F	12	0-16(1-16channel,Off)	-	16(Off)
	Modulation Receive	7F	13	0,1(Off,On)	-	1(On)
	Exp Receive	7F	14	0,1(Off,On)	-	0(Off)
	Slow/Fast Control Type	7F	15	0,1(UnLatch,Latch)	-	1(Latch)
	Slow/Fast Control Code	7F	16	0-99	-	64
Other	Preset Foot Switch Type	7F	17	0,1(UnLatch,Latch)	-	0(UnLatch)
	Les lie Mode	7F	18	0-2(Slow,Fast,Brake)	-	0(Slow)

***1 Horn Slow Speed**

Data LSB		rpm
Dec	Hex	
0	00	0
1	01	24
2	02	27
3	03	31
4	04	33
5	05	36
6	06	40
7	07	42
8	08	46
9	09	48
10	0A	50
11	0B	52
12	0C	57
13	0D	61
14	0E	63
15	0F	65
16	10	68
17	11	72
18	12	76
19	13	78
20	14	80
21	15	84
22	16	87
23	17	91
24	18	93
25	19	97
26	1A	100
27	1B	102
28	1C	106
29	1D	108
30	1E	112
31	1F	114
32	20	117
33	21	121
34	22	123
35	23	127
36	24	130
37	25	132
38	26	136
39	27	138
40	28	142
41	29	145
42	2A	147
43	2B	151
44	2C	153
45	2D	157
46	2E	160
47	2F	162
48	30	166
49	31	168

Data LSB		rpm
Dec	Hex	
50	32	172
51	33	174
52	34	178
53	35	181
54	36	183
55	37	187
56	38	189
57	39	193
58	3A	195
59	3B	198
60	3C	202
61	3D	204
62	3E	208
63	3F	210
64	40	213
65	41	217
66	42	219
67	43	223
68	44	225
69	45	229
70	46	231
71	47	234
72	48	238
73	49	240
74	4A	243
75	4B	247
76	4C	249
77	4D	253
78	4E	255
79	4F	258
80	50	262
81	51	264
82	52	267
83	53	271
84	54	273
85	55	276
86	56	280
87	57	282
88	58	286
89	59	288
90	5A	291
91	5B	295
92	5C	297
93	5D	300
94	5E	302
95	5F	306
96	60	309
97	61	311
98	62	315
99	63	318

***2 Horn Fast Speed**

Data LSB		rpm
Dec	Hex	
1	01	376
2	02	378
3	03	382
4	04	384
5	05	387
6	06	391
7	07	393
8	08	397
9	09	400
10	0A	402
11	0B	406
12	0C	408
13	0D	411
14	0E	414
15	0F	418
16	10	421
17	11	424
18	12	427
19	13	430
20	14	431
21	15	435
22	16	438
23	17	442
24	18	444
25	19	447
26	1A	450
27	1B	452

***5 Horn Rotor Time**

Data LSB		time second	Display
Dec	Hex		
0	00	0.2	0.2
1	01	0.4	0.4
2	02	0.6	0.6
3	03	0.8	0.8
4	04	1.0	1.0
5	05	1.2	1.2
6	06	1.4	1.4
7	07	1.6	1.6
8	08	1.8	1.8
9	09	2.0	2.0
10	0A	2.2	2.2
11	0B	2.4	2.4
12	0C	2.6	2.6
13	0D	2.8	2.8
14	0E	3.0	3.0
15	0F	3.2	3.2
16	10	3.4	3.4
17	11	3.6	3.6
18	12	3.8	3.8
19	13	4.0	4.0
20	14	4.2	4.2
21	15	4.4	4.4
22	16	4.6	4.6
23	17	4.8	4.8
24	18	5.0	5.0
25	19	5.5	5.5
26	1A	6.0	6.0
27	1B	6.5	6.5
28	1C	7.0	7.0
29	1D	7.5	7.5
30	1E	8.0	8.0
31	1F	8.5	8.5
32	20	9.0	9.0
33	21	9.5	9.5
34	22	10.0	10
35	23	10.5	10.
36	24	11.0	11
37	25	11.5	11.
38	26	12.0	12
39	27	12.5	12.

***6 Low Rotor Time**

Data LSB		time second	Display
Dec	Hex		
0	00	0.5	0.5
1	01	1.0	1.0
2	02	1.5	1.5
3	03	2.0	2.0
4	04	2.5	2.5
5	05	3.0	3.0
6	06	3.5	3.5
7	07	4.0	4.0
8	08	4.5	4.5
9	09	5.0	5.0
10	0A	5.5	5.5
11	0B	6.0	6.0
12	0C	6.5	6.5
13	0D	7.0	7.0
14	0E	7.5	7.5
15	0F	8.0	8.0
16	10	8.5	8.5
17	11	9.0	9.0
18	12	9.5	9.5
19	13	10.0	10
20	14	10.5	10.
21	15	11.0	11
22	16	12.0	12
23	17	13.0	13
24	18	14.0	14

***7 Horn Character mk2**

Data LSB		Character	Display
Dec	Hex		
0	00	Flat	FL
1	01	1.0k	1.0
2	02	1.6k	1.6
3	03	2.0k	2.0

***8 Cabinet Character mk2**

Data LSB		Character	Display
Dec	Hex		
0	00	122	12
1	01	21H	21
2	02	brite	br
3	03	flat	FL

MIDI Information

[Channel Voice Message]

Control Change

The value set by the Control Change is not reset even when Program Change messages etc. are received.

Modulation(Leslie Speed)

Status	2nd Byte	3rd Byte
Bn	01	vv

n=MIDI Channel Number: 0 - F(Ch.1 - 16)

vv=Modulation Depth: 00 - 7F

Data Entry

Status	2nd Byte	3rd Byte
Bn	06	mm
Bn	26	ll

(MSB)

(LSB)

n=MIDI Channel Number: 0 - F(Ch.1 - 16)

mm,ll=Value for the Parameter designated by NRPN.

Expression(Leslie Speed)

Status	2nd Byte	3rd Byte
Bn	0B	vv

n=MIDI Channel Number: 0 - F(Ch.1 - 16)

vv=Expression: 00 - 7F(0 - 127)

Default Value = 7F(127)

Korg Rotary Fast Code

Status	2nd Byte	3rd Byte
Bn	52	vv

n=MIDI Channel Number: 0 - F(Ch.1 - 16)

vv=Control Value: 00 - 7F(0 - 127) 0-63 = Off, 64-127 = On

Korg Rotary Brake Code

Status	2nd Byte	3rd Byte
Bn	53	vv

n=MIDI Channel Number: 0 - F(Ch.1 - 16)

vv=Control Value: 00 - 7F(0 - 127) 0-63 = Off, 64-127 = On

Hold 1(Leslie Slow/Fast initial Code)

Status	2nd Byte	3rd Byte
Bn	40	vv

n=MIDI Channel Number: 0 - F(Ch.1 - 16)

vv=Control Value: Leslie Slow/Fast Control Type=Mormentary:

00 - 7F(0 - 127) 0-63 = Off, 64-127 = On

Leslie Slow/Fast Control Type=Altarnate:

00 - 7F(0 - 127) 64-127 = Latch

NRPN MSB/LSB

Status	2nd Byte	3rd Byte
Bn	63	mm
Bn	62	ll

(MSB)

(LSB)

n=MIDI Channel Number: 0 - F(Ch.1 - 16)

mm=Upper Byte of the Parameter Number designated by NRPN[MSB].

ll=Lower Byte of same[MSB].

NRPN- "Non Registered Parameter Number"

The expansive range named NRPN is provided in the Control Change, which function is specific on each equipment and not defined in the MIDI Standard.

When you use it, designate the parameter to control, by gibing NRPN MSB and NRPN LSB (cc#98 and 99), and the set the value of the designated parameter by the Data Entry MSB(cc#6).

Once the NRPN parameter is designated, all the data entry received into the same channel after that is regarded as the change of the value of the parameter. To avoid any mis-operation, we suggest you to set RPN Null (RPN = 7F 7F), after setting the necessary parameter value.

Program Change

Status	2nd Byte
Cn	pp

n=MIDI Channel Number: 0 - F(Ch.1 - 16)

pp=Program Number 0:presel1 1:presel2

Program Channel: Change Preset.

System Exclusive Message

Memory Dump

F0	System Exclusive
55	SUZUKI ID
10	Device ID
10	Model ID MSB
1C	Model ID LSB
11	Command: Data Packet
[TYPE]	Data Type
	00h= Memory Dump
[PNH]	Packet Number MSB
[PNL]	Packet Number LSB
[DATA]	128 Bytes Data
	256 Bytes nibblized ASCII
	ex: 7Eh = 37h, 45h
[CHD]	Check Digit
	Lower 7 bits of XOR [DATA]
F7	End of Exclusive

Roland Leslie Slow Fast

F0	System Exclusive
41	Roland ID
10	Device ID
00	Model ID MSB
08	Model ID LSB
12	Command ID
02	address1
00	address2
10	address3
3D	address4
[DATA]	00:Slow 01:Fast
[SUM]	no check
F7	End of Exclusive

Leslie
Model: 2101mk2

MIDI Implementation Chart

Date: 26-Aug-2008
Version: 1.0

Function		Transmitted	Recognized	Remarks
Basic Channel	Default Changed	1 1 - 16	1 1 - 16	ControlChannel=1 ProgramChannel=Off
Mode	Default Messages Altered	3 X *****	3 X X	
Note Number	: True Voice	X *****	X X	
Velocity	Note ON Note OFF	X X	X X	
After Touch	Key's Ch's	X X	X X	
Pitch Bender		X	X	
Control Change		1 O	O	Modulation
		6,38 O	O	Data Entry
		11 X	O	Expression(LeslieSpeed)
		82 X	O	Korg Rotary Fast
		83 X	O	Korg Rotary Brake
		64 X	O	Hold1(Slow/Fast)
		98,99 O	O	NRPN LSB, MSB
Program Change	: True #	O 0 - 1 *****	O 0 - 1 O 0 - 1	
System Exclusive		O	O	
System Common	: Song Position : Song Select : Tune	X X X	X X X	
System Real Time	: Clock : Commands	X X	X X	
Aux Messages	: Local On/Off : All Notes Off : Active Sense : Reset	X X X X	X X X X	

Mode 1: OMNI ON, POLY
Mode 3: OMNI OFF, POLY

Mode 2: OMNI ON, MONO
Mode 4: OMNI OFF, MONO

O: Yes
X: No

Leslie 2101 mk2 正誤表

ページ	行	項目	誤	正
6P	内部システム図内	LINE OUT	L/MONO	L
8P	27 行目	LINE OUT STATIONARY&BASS	L/MONO OUT を	文を削除
8P	32 行目	LINE OUT ROTARY	L/MONO OUT を	文を削除
8P	51 行目	FOOT SW SLOW/FAST/STOP		(Brake Time を OFF にすると Brake 処理しません。)を追記
12P	10 行目		HORN LEVEL	HORN ROT.LEVEL
12P	11 行目		LOWER LEVEL	LOW ROT.LEVEL
17P	17 行目	S/F Cont.Code	工場出荷時は 64(ダンパー)で、0~99の…	工場出荷時は 82 で、0~97の…

Preset (Leslie) Parameters

Category	Parameter	NRPN ADR.		DATA Range		Default	
		LSB (62)	MSB (63)	MSB (06)	LSB (26)	Preset1	Preset2
Horn Rotor	Slow Speed	7F	00	0-99 (0,24-318rpm) *1	-	8(46rpm)	8(46rpm)
	Fast Speed	7F	02	1-27(375-450rpm) *2	-	9(400rpm)	9(400rpm)
	Rise Time	7F	04	0-39(0.2-12.5s) *5	-	1.8s	3.0s
	Fall Time	7F	06	0-39(0.2-12.5s) *5	-	2.4s	3.0s
	Brake Time	7F	08	0-39(0.2-12.5s),OFF *5	-	3.0s	3.0s
	Horn Character(mk2)	7F	1C	0-3(FL,1.0k,1.6k,2.0k) *7	-	FL	FL
Rot Level	7F	19	0-99	-	50	50	
Low Rotor	Slow Speed	7F	01	0-9(0,24-48rpm) *3	-	3(31rpm)	3(31rpm)
	Fast Speed	7F	03	1-21(372-431rpm) *4	-	1(376rpm)	1(376rpm)
	Rise Time	7F	05	0-24(0.5-14.0s) *6	-	12s	13s
	Fall Time	7F	07	0-24(0.5-14.0s) *6	-	5.5s	12s
	Brake Time	7F	09	0-24(0.5-14.0s),OFF *6	-	10s	14s
	Rot Level	7F	1A	0-99	-	99	99
Bass Level	7F	1B	0-99	-	90	90	
Horn&Low Rotor	CrossOver Frequency	7F	0E	0-2(0.7k,0.8k,1.0k)	-	0.8k	0.8k
	Cabinet Character(mk2)	7F	1D	0-3(12,21,br,FL) *8	-	12(122)	21(21H)

System Parameters

Category	Parameter	NRPN ADR.		DATA Range		Default
		LSB (62)	MSB (63)	MSB (06)	LSB (26)	
Preset	Preset Number	7F	10	0,1(Preset1,Preset2)	-	0(Preset1)
MIDI System	Control Channel	7F	11	0-16(1-16channel,Off)	-	0(1Channel)
	Program Channel	7F	12	0-16(1-16channel,Off)	-	16(Off)
	Modulation Receive	7F	13	0,1(Off,On)	-	1(On)
	Exp Receive	7F	14	0,1(Off,On)	-	0(Off)
	Slow/Fast Control Type	7F	15	0,1(UnLatch,Latch)	-	1(Latch)
	Slow/Fast Control Code	7F	16	0-99	-	82
Other	Preset Foot Switch Type	7F	17	0,1(UnLatch,Latch)	-	0(UnLatch)
	Leslie Mode	7F	18	0-2(Slow,Fast,Brake)	-	0(Slow)

<マニュアル内 挿絵 変更>

12P ■接続例(1) 2101mk2 1台、2121 1台を組み合わせた モノラル接続

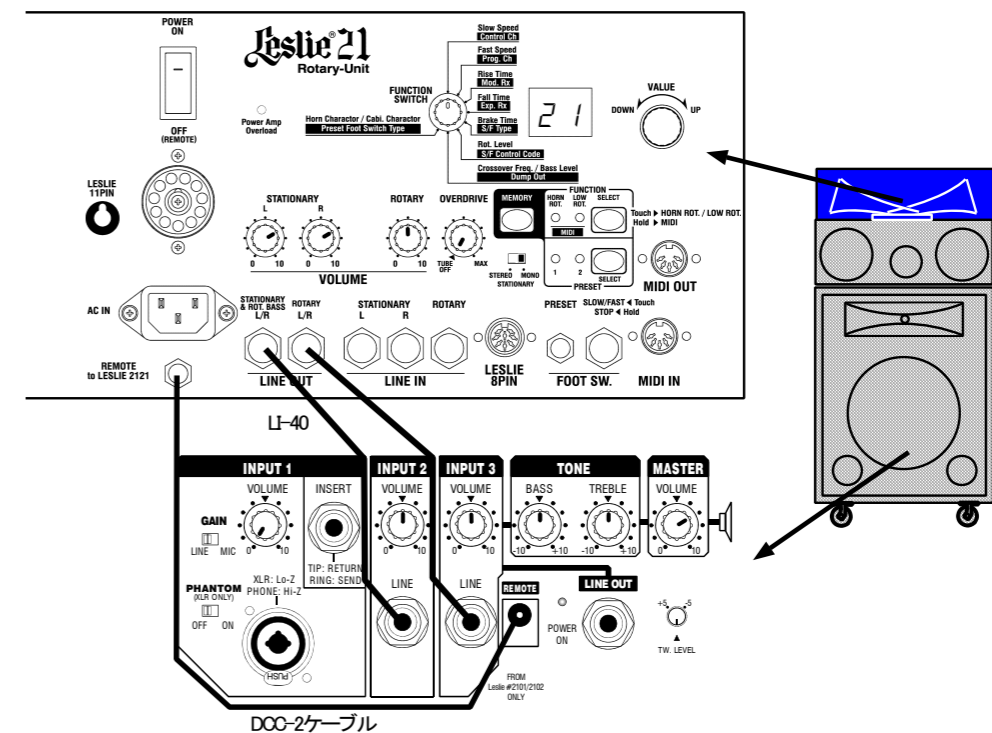

13Pの接続例においても、つまみ位置は上図を参考にしてください。

Leslie 2101 mk2 Corrections

Page	Line	Item	Incorrect	Correct
7	System Illustration	LINE OUT	L/MONO	L
8	27	LINE OUT STATIONARY&BASS	L/MONO OUT	this jack
8	30	LINE OUT ROTARY	L/MONO OUT	this jack
8	bottom	FOOT SW SLOW/FAST/STOP		add: It does not BRAKE when the Brake Time is "OFF".
13	7		HORN LEVEL: 90 / LOWER LEVEL: 99	HORN ROT. LEVEL: 90 / LOW ROT. LEVEL: 99
18	19	S/F Cont.Code	The factory default is CC#64. The range is CC#0 - #99	The factory default is CC#82. The range is CC#0 - #97

Preset (Leslie) Parameters

Category	Parameter	NRPN Adr.		DATA Range			Default	
		LSB (62)	MSB (63)	MSB (06)	LSB (26)	Preset1	Preset2	
Horn Rotor	Slow Speed	7F	00	0 - 99 (0,24-318rpm) *1	-	8(46rpm)	8(46rpm)	
	Fast Speed	7F	02	1 - 27(375-450rpm) *2	-	9(400rpm)	9(400rpm)	
	Rise Time	7F	04	0-39(0.2-12.5s) *5	-	1.8s	3.0s	
	Fall Time	7F	06	0-39(0.2-12.5s) *5	-	2.4s	3.0s	
	Brake Time	7F	08	0-39(0.2-12.5s),OFF *5	-	3.0s	3.0s	
	Horn Character(mk2)	7F	1C	0-3(FL,1.0k,1.6k,2.0k) *7	-	FL	FL	
	Rot Level	7F	19	0-99	-	50	50	
Low Rotor	Slow Speed	7F	01	0-9(0,24-48rpm) *3	-	3(31rpm)	3(31rpm)	
	Fast Speed	7F	03	1-21(372-431rpm) *4	-	1(376rpm)	1(376rpm)	
	Rise Time	7F	05	0-24(0.5-14.0s) *6	-	12s	13s	
	Fall Time	7F	07	0-24(0.5-14.0s) *6	-	5.5s	12s	
	Brake Time	7F	09	0-24(0.5-14.0s),OFF *6	-	10s	14s	
	Rot Level	7F	1A	0-99	-	99	99	
	Bass Level	7F	1B	0-99	-	90	90	
Horn&Low Rotor	CrossOver Frequency	7F	0E	0-2(0.7k,0.8k,1.0k)	-	0.8k	0.8k	
	Cabinet Character(mk2)	7F	1D	0-3(12,21,br,FL) *8	-	12(122)	21(21H)	

System Parameters

Category	Parameter	NRPN Adr.		DATA Range			Default
		LSB (62)	MSB (63)	MSB (06)	LSB (26)		
Preset	Preset Number	7F	10	0,1(Preset1,Preset2)	-	0(Preset1)	
MIDI System	Control Channel	7F	11	0-16(1-16channel,Off)	-	0(1Channel)	
	Program Channel	7F	12	0-16(1-16channel,Off)	-	16(Off)	
	Modulation Receive	7F	13	0,1(Off,On)	-	1(On)	
	Exp Receive	7F	14	0,1(Off,On)	-	0(Off)	
	Slow/Fast Control Type	7F	15	0,1(UnLatch,Latch)	-	1(Latch)	
	Slow/Fast Control Code	7F	16	0-99	-	82	
Other	Preset Foot Switch Type	7F	17	0,1(UnLatch,Latch)	-	0(UnLatch)	
	Leslie Mode	7F	18	0-2(Slow,Fast,Brake)	-	0(Slow)	

< Illustration Correction >

Page 13: Connecting the Leslie 2121 Stationary Unit

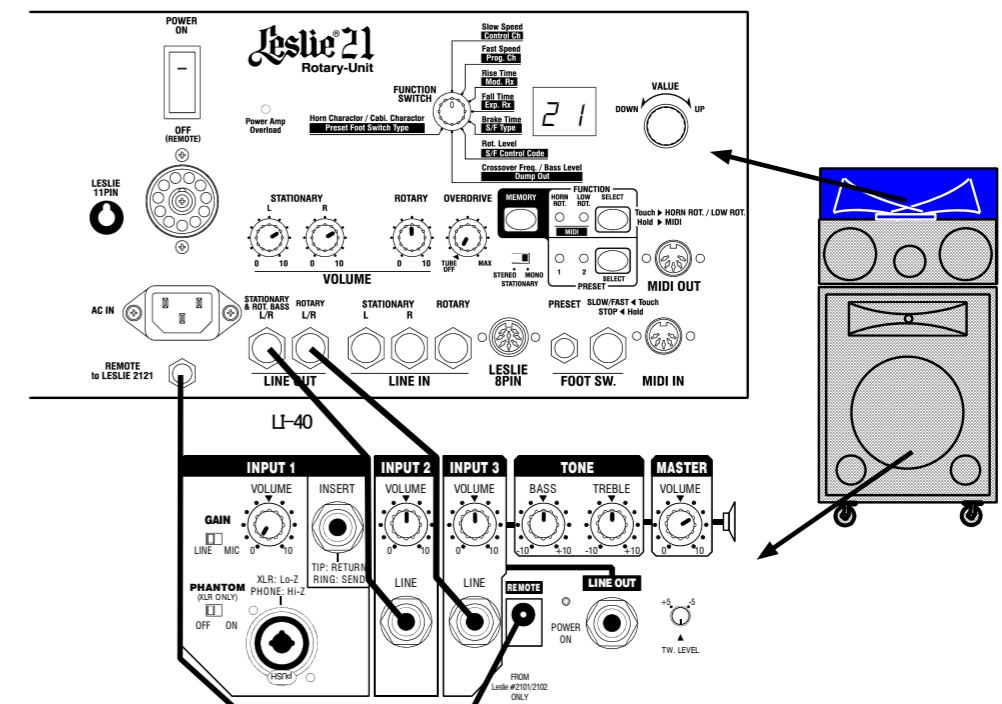

Set the knobs at the same positions as shown above and on page 14.